

BTRS-3702MG / BTRS-3702AMG

1550 nm TX / 1310 nm RX , 3.3V / 125 Mbps **RoHS Compliant** Single-Fiber MM Transceiver

FEATURES

- | Single Fiber Bi-Directional MM Transceiver
- | 1550 nm Transmitter
- | 1310 nm Receiver
- | Distance 0 to 2000 m
- | 0 to 70°C Operating: BTRS-3702MG
- | -20 to 85°C Operating : BTRS-3702AMG
- | 2x5 Package with SC Receptacle
- | Single +3.3 V Power Supply
- | RoHS Compliant
- | PECL Differential Inputs and Outputs
- | Wave Solderable and Aqueous Washable
- | Class 1 Laser International Safety Standard IEC-60825 Compliant

APPLICATIONS

- | WDM 155 Mb/s Links
- | SONET/SDH Equipment Interconnect
- | Fast Ethernet 100 Mb/s Links

DESCRIPTION

The BTRS-3702MG series is high performance module for multi-mode single fiber communications by using 1550 nm transmitter and 1310 nm receiver. The transmitter section uses a multiple quantum well laser and is a class 1 laser compliant according to International Safety Standard IEC-60825. The receiver section uses an integrated 1310 nm detector preamplifier (IDP) mounted in an optical header and a limiting post-amplifier IC. A PECL logic interface simplifies interface to external circuitry.

LASER SAFETY

This multi-mode transceiver is a Class 1 laser product. It complies with IEC-60825 and FDA 21 CFR 1040.10 and 1040.11. The transceiver must be operated within the specified temperature and voltage limits. The optical ports of the module shall be terminated with an optical connector or with a dust plug.

ORDER INFORMATION

P/No.	Bit Rate (Mb/s)	Distance (m)	TX (nm)	RX (nm)	Voltage (V)	Package	Temp (°C)	TX Power (dBm)	RX Sens. (dBm)	RoHS Compliant
BTRS-3702MG	125	0 to 2000	1550	1310	3.3	2X5 SC	0 to 70	-8 to -15	-30	Yes
BTRS-3702AMG	125	0 to 2000	1550	1310	3.3	2X5 SC	-20 to 85	-8 to -15	-30	Yes

Absolute Maximum Ratings					
Parameter	Symbol	Min	Max	Units	Notes
Storage Temperature	Tstg	-40	85	°C	
Operating Temperature	Topr	0 -20	70 85	°C	BTRS-3702MG BTRS-3702AMG
Soldering Temperature	---		260	°C	10 seconds on leads only
Power Supply Voltage	Vcc	0	4.5	V	
Input Voltage	---	GND	Vcc	V	
Output Current	Iout	0	30	mA	

Recommended Operating Conditions					
Parameter	Symbol	Min	Typ	Max	Units / Notes
Power Supply Voltage	Vcc	3.13	3.3	3.47	V
Operating Temperature	Topr	0 -20		70 85	°C / BTRS-3702MG °C / BTRS-3702AMG
Data Rate			125	170	Mb/s
Power Supply Current	Icc			240	mA

Transmitter Specifications (0°C < Topr < 70°C, 3.13V < Vcc < 3.47V)						
Parameter	Symbol	Min	Typ	Max	Units	Notes
Optical						
Optical Transmit Power	Po	-15		-8	dBm	1
Output Center Wavelength	λ	1480		1580	nm	
Output Spectrum Width	σ_λ			10	nm	RMS (σ)
Extinction Ratio	ER	8.2			dB	
Optical Rise Time	t _r			2	ns	10% to 90% Values
Optical Fall Time	t _f			2	ns	10% to 90% Values
Relative Intensity Noise	RIN			-116	dB/Hz	
Total Jitter	TJ			1	ns	2
Electrical						
Data Input Current – Low	I _{IL}	-350			μ A	
Data Input Current – High	I _{IH}			350	μ A	
Differential Input Voltage	V _{IH} - V _{IL}	300		1600	mV	
Data Input Voltage – Low	V _{IL} - V _{CC}	-2.0		-1.58	V	3
Data Input Voltage -- High	V _{IH} - V _{CC}	-1.1		-0.74	V	3
Disable Input Voltage -- Low	V _{TDISL}	0		0.8	V	TX Output Enabled
Disable Input Voltage -- High	V _{TDISH}	V _{CC} - 1.3		V _{CC}	V	TX Output Disabled
Shut Off Time for TxDis	t _{DIS}			1	ms	

- Notes: 1. Output power is power coupled into a 62.5/125 μ m multi-mode fiber.
 2. Measured with a 2²³-1 PRBS with 72 ones and 72 zeros.
 3. These inputs are compatible with 10K, 10KH and 100K ECL and LVPECL inputs.

Receiver Specifications (0°C < Topr < 70°C, 3.13 V < Vcc < 3.47V)						
Parameter	Symbol	Min	Typ	Max	Units	Notes
Optical						
Sensitivity	---	---	---	-30	dBm	1
Maximum Input Power	Pin	-8	---	---	dBm	
Signal Detect -- Asserted	Pa	---	---	-30	dBm	Transition: low to high
Signal Detect -- Deasserted	Pd	-43	---	---	dBm	Transition: high to low
Signal detect -- Hysteresis		1.0	---	4.0	dB	
Wavelength of Operation		1260		1360	nm	2
Optical Return Loss	ORL	14			dB	
Electrical						
Data Output Voltage – Low	V _{OL} - V _{CC}	-2.0		-1.58	V	3
Data Output Voltage – High	V _{OH} - V _{CC}	-1.1		-0.74	V	3
SD Output Voltage -- Low	V _{OL} - V _{CC}	-2.0		-1.58	V	3
SD Output Voltage -- High	V _{OH} - V _{CC}	-1.1		-0.74	V	3
Signal Detect Assert Time	AS _{MAX}			100	μ s	OFF to ON
Signal Detect Deassert Time	ANS _{MAX}			300	μ s	ON to OFF

- Notes: 1. Minimum sensitivity and saturation levels at BER 1E-10 for a 2⁷-1 PRBS.
 2. At least 30 dB optical isolation for the wavelength 1480 to 1580 nm.
 3. These outputs are compatible with 10K, 10KH and 100K ECL and LVPECL outputs.

CONNECTION DIAGRAM

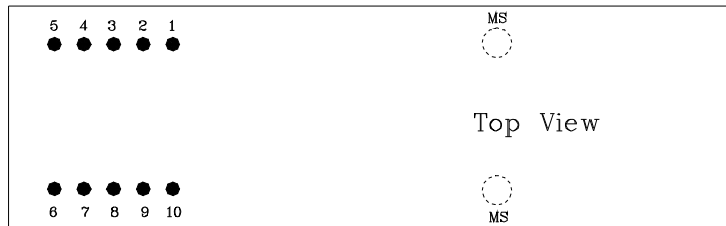

PIN	Symbol	Notes
1	V_{EE}^r	Directly connect this pin to the receiver ground plane
2	V_{CC}^r	+3.3V dc power for the receiver section
3	SD	Active high on this indicates a received optical signal.
4	RD-	Receiver Dataout Bar. See recommended circuit schematic
5	RD+	Receiver Dataout. See recommended circuit schematic
6	V_{CC}^t	+3.3V dc power for the transmitter section
7	V_{EE}^t	Directly connect this plan to the transmitter ground plane
8	TxDis	Transmitter Disable. Connect this pin to +3.3V TTL logic "1" to disable module To enable module connect to TTL logic low "0"
9	TD+	Transmitter Data In. See recommended circuit schematic
10	TD-	Transmitter Data In Bar. See recommended circuit schematic
MS	MS	Mounting Studs. Connect to Chassis Ground

RECOMMENDED CIRCUIT SCHEMATIC

Recommended AC Coupled Interface Circuit

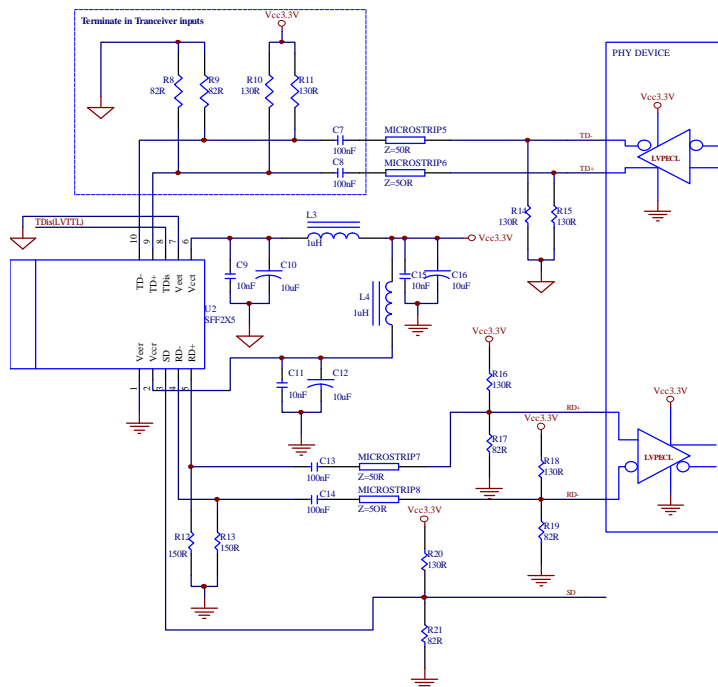

PACKAGE DIAGRAM

Units in mm

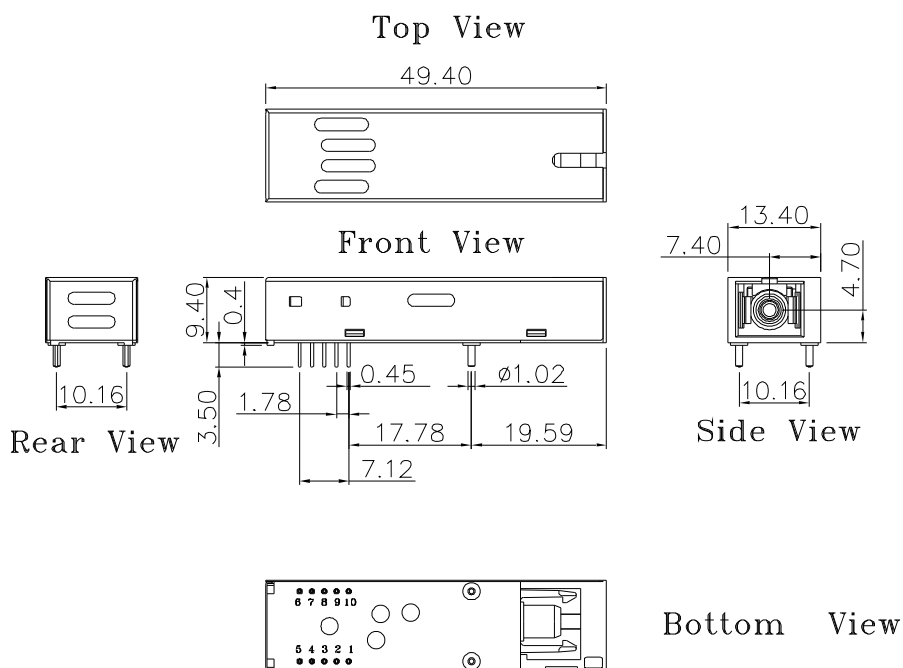

Note: Specifications subject to change without notice.